

UTAH-400

Digital Routing Switcher Family

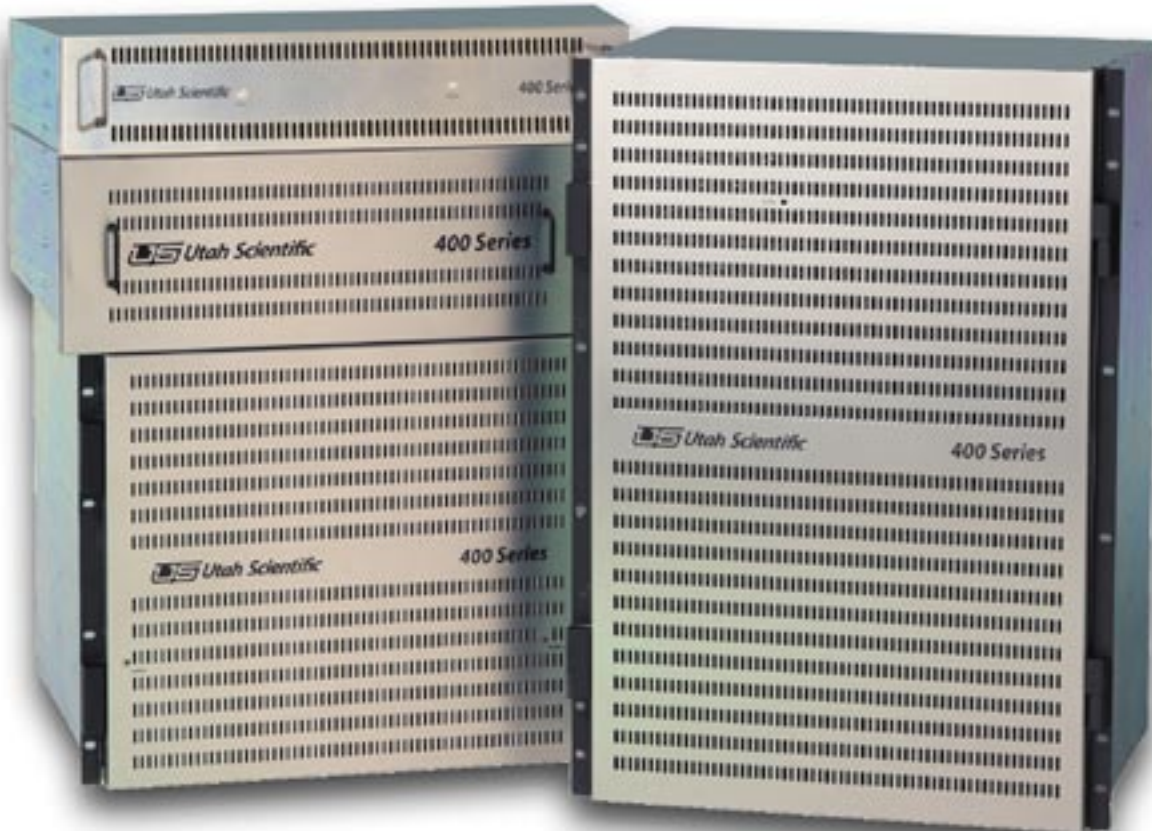

Utah Scientific has been involved in the design and manufacture of routing switchers for audio and video signals for over thirty years. Starting with our original AVS-1 router and moving through several generations of routing switcher design to the current UTAH-400 series for all signal formats, we have participated in the evolution of the broadcast television industry from analog composite through components and various forms of digital video and audio to today's complex mixed environment of analog and multiple digital signal formats.

The UTAH-400 was developed to provide a single platform for all digital router applications from very small to extremely large matrix configurations and to handle all digital signal formats. Thanks to an innovative matrix architecture, the UTAH-400 is readily scalable from 8x8 to 1152x1152 and beyond using a single family of matrix building blocks. In addition to this flexibility of configuration, the UTAH-400 offers tremendous reductions in the physical space and power consumption requirements.

The UTAH-400 uses a three-board architecture consisting of an input board, a crosspoint board, and an output board. All frames and internal signal distribution components are designed for HD signal compatibility, providing full insurance that an SD system can be upgraded to 3G HD operation by simply exchanging the signal I/O modules. The UTAH-400 family consists of audio and video frames for 32x32, 64x64, 144x144, and 288x288 matrix sizes. All of these frames use a common set of modules described below.

MODULE DESCRIPTIONS

INPUT BOARD

The input board carries eight identical receiver / buffer circuits for bringing the input signals from the rear panel into the matrix and delivering them to the crosspoint board. Each input circuit has a signal presence detector that can send an alarm to the frame’s alarm processor when it detects a loss of signal on the input. The Standard Definition version of the Input Board provides automatic equalization for up to 300 meters of type 8281 or equivalent cable at the input. The optional High Definition version of the Input Board offers 100 meters of equalization and can accept digital video signals at any data rate up to 3Gbps.

CROSSPOINT BOARD

The crosspoint board receives its inputs from the input cards and applies these signals to the crosspoint array. This array is fitted with the appropriate number of integrated circuit crosspoints for the frame in which it is to be used. The crosspoint board’s control inputs come from the system controller by way of a pair of Utah MX-Bus connectors mounted on the frame’s rear panel. The outputs of the crosspoint array are passed onto the Output Boards by the Output Bus.

OUTPUT BOARD

The Output Board carries eight identical driver circuits that buffer the signals from the Output Bus and present them to the connectors at the rear panel of the frame. Each output circuit has a signal presence detector for alarm reporting and automated troubleshooting and a reclocking circuit to ensure maximum signal quality at the output of the matrix.

DIGITAL AUDIO MATRICES

The UTAH-400 digital audio switchers offers a number of innovative functional improvements over existing audio routers, including synchronous / asynchronous operation. The UTAH-400 AES switcher also offers the option to control the configuration of AES/EBU digital audio signals within the router to allow channel swapping and mixing, and for “soft transitions”, completely eliminating pops and clicks that can accompany the switching of digital audio signals. UTAH-400 AES routers are available with balanced or unbalanced I/O ports. Matching transformers are available as an option.

INTERNAL SIGNAL FORMAT CONVERSION

The UTAH-400’s digital I/O cards can be replaced as required with cards that feature on-board Analog-to-Digital or Digital-to-Analog format conversion, giving the UTAH-400 the unique ability to provide analog inputs and/or outputs in blocks of 8 ports per board.

UTAH-400 BLOCK DIAGRAM

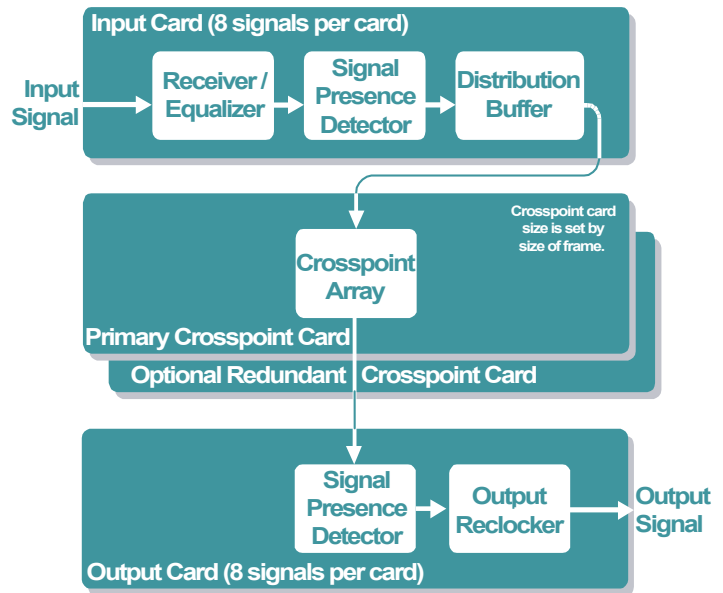

UTAH-400 FEATURES

SIGNAL PRESENCE DETECTION — The UTAH-400 has signal presence detectors on all inputs and outputs, allowing the matrix to perform a number of unique functions — ranging from simple alarms to automatic restoration of service on critical signal paths.

CROSSPOINT REDUNDANCY OPTIONS — The UTAH-400's unique architecture allows us to place fully redundant crosspoint assemblies in each matrix frame for the ultimate degree of operational reliability.

INTERNAL MONITOR MATRIX — Each UTAH-400 Chassis is equipped with an internal monitor matrix for monitoring any of the output busses carried in that chassis. In multi-chassis systems, the monitor bus outputs from each chassis can be combined to provide a single monitor bus that can select any output in the system for monitoring.

REDUNDANT POWER SUPPLIES — All UTAH-400 systems are supplied with dual power supplies for each frame. These supplies operate in a fully redundant configuration with complete alarm and monitoring capabilities.

REDUNDANT CONTROL CARDS — To further insure operational reliability, all UTAH-400 systems can be supplied with dual control cards in each frame.

LOW POWER CONSUMPTION — The UTAH-400 switchers are designed for extremely low power consumption. This translates to direct savings on operational expense and increased long-term reliability.

This capability can be used to provide analog monitoring of the signals in the digital router or to provide a simple way to integrate analog source and destination equipment into the digital routing system.

FIBER OPTIC I/O OPTION

The UTAH-400 routers are available with optional Fiber I/O in place of the normal coax. Please consult the Fiber I/O Product Information Sheet for details.

ADVANCED CONTROL FACILITIES

The UTAH-400 offers a glimpse into the future of routing switcher design with its unique signal presence monitoring capability. By continuously monitoring the presence of digital bit streams at each input and each output, the system can support automatic rerouting, or "protection switching", to restore a signal feed that is interrupted by an internal or external fault. For example, simple logic instructions can be set up to cause the switcher to switch a given output to a secondary input if there is loss of signal on the primary input. Using the same logic facilities, the system can check for signal presence on the active input when it detects loss of signal on an output before sending an alarm to the operator.

LARGE ROUTER SYSTEMS

The UTAH-400 family also contains a variety of routers designed for system sizes larger than 288x288. Please see the UTAH-400 Large Routing Systems and the UTAH-400 Multi-Frame Routing Systems Product Information Sheets for details on these products.

UTAH-400/32

Matrix Sizes up to 32x32



The UTAH-400/32 is the smallest frame in the series, bringing all of the features of the UTAH-400 High Density Digital Routing Switcher family to smaller matrix size applications. Housed in a compact, 2 RU frame that includes dual power supplies and dual crosspoint/controller cards, the UTAH-400/32 offers matrix sizes from 8x8 to 32x32.

The UTAH-400/32 uses the same I/O boards that are used in the larger frames. A major advantage of this approach is that if the matrix needs to be expanded to a larger frame, the I/O modules can be re-used in the new matrix.

To save space, the UTAH-400/32 uses a combination control/crosspoint card instead of separate cards for the two functions. The frame can optionally be fitted with Redundant Crosspoint/Control Cards that provide full backup against an internal path failure in the matrix.

UTAH-400/32 frames can be controlled by the same control bus connections used by the larger frames. They also offer the flexibility of having internal controller boards for standalone applications.

Thanks to the UTAH-400's unique 8-port I/O cards, smaller matrices can be easily expanded in very cost-effective increments. The full range of I/O options is available in the smaller frame, including analog I/O cards for the ultimate in system flexibility.

Dual power supplies are standard — just like the larger frames.

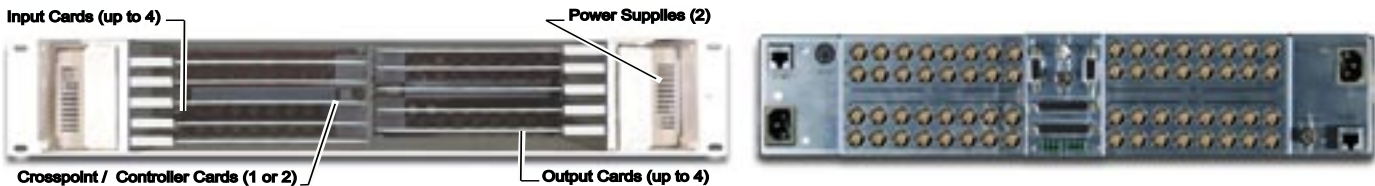

UTAH-400/64

Matrix Sizes up to 64x64



The UTAH-400/64 brings all of the features of the UTAH-400 High Density Digital Routing Switcher family to the lower end of the mid-size matrix applications. Housed in a compact, 4 RU frame that includes dual power supplies, the UTAH-400/64 offers matrix sizes from 8x8 to 64x64.

Thanks to the UTAH-400's unique 8-port I/O cards, smaller matrices can be easily expanded in very cost-effective increments. The full range of I/O options is available in the smaller frame, including analog I/O cards for the ultimate in system flexibility.

UTAH-400/64 frames use the same I/O modules as the larger UTAH-400 frames. The UTAH-400/64 frame can be fitted with an optional Redundant Crosspoint Card that provides full backup against an internal path failure in the matrix.

UTAH-400/64 frames can be controlled by the same control bus connections used by the larger frames. They also offer the option of having single or redundant internal SC-400 controller boards for stand-alone applications.

The UTAH-400/64 and /32 frames are especially well suited for use with the MC-400 Master Control Output Card for multi-channel systems where it makes sense to have the master control system work with a selected subset of sources rather than all of the sources available on a larger router.



UTAH-400/144

Matrix Sizes up to 144x144

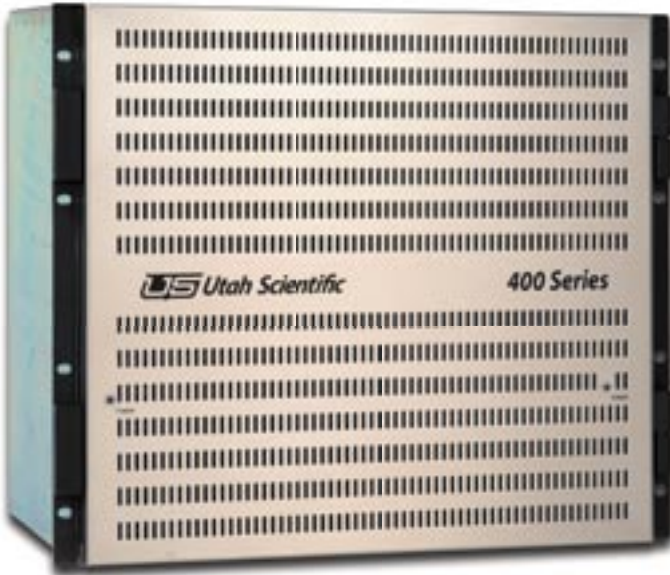

The UTAH-400/144 is designed for the upper end of the range of mid-size router applications. Housed in a compact, 9 RU frame, including dual power supplies and dual controller cards, the UTAH-400/144 will support matrix sizes from 8x8 to 144x144.

Thanks to the UTAH-400's unique 8-port I/O cards, matrices can be easily expanded in very cost-effective increments. The full range of I/O options is available in the 144 frame, including fiber and analog I/O cards for the ultimate in system flexibility.

Like the other frames in this series, the UTAH-400/144 frame can be fitted with an optional Redundant Crosspoint Card that provides full backup against an internal path failure in the matrix.

UTAH-400/144 frame is controlled by the same control bus connections used by the smaller frames.

Input Cards (up to 18)

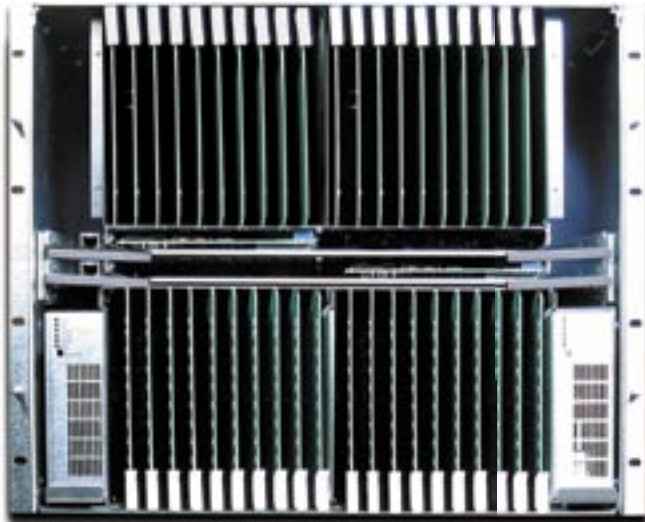

Output Cards (up to 18)

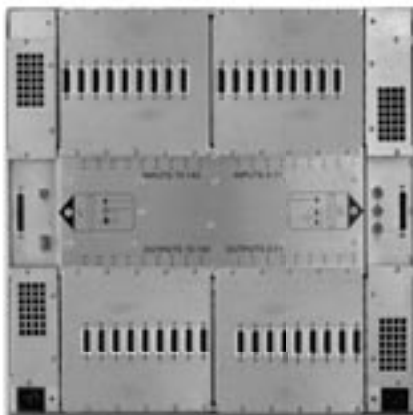

Audio Matrix Rear Panel

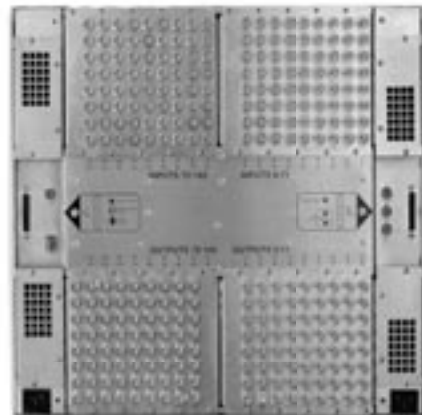

Video Matrix Rear Panel

UTAH-400/288

The UTAH-400/288 brings all of the features of the UTAH-400 High Density Digital Routing Switcher family to large matrix size applications. Housed in a compact, 16 RU frame, the UTAH-400/288 will support matrix sizes from 8x8 to 288x288.

Thanks to the UTAH-400's unique 8-port I/O cards, matrices can be easily expanded in very cost-effective increments. The full range of I/O options is available in the 288 frame, including fiber and analog I/O cards for the ultimate in system flexibility.

In addition, the UTAH-400/288 frame can be fitted with an optional Redundant Crosspoint Card that provides full backup against an internal path failure in the matrix.

The UTAH-400/288 frame has dual power inputs that are fed with power at 48VDC from an external 1RU power rectifier frame with dual redundant rectifier units. For applications where 48VDC power is available from an external source the frame can be fed directly, eliminating the need for the rectifier frame.

UTAH-400/288 frame is controlled by the same control bus connections used by the smaller frames.

Matrix Sizes up to 288x288

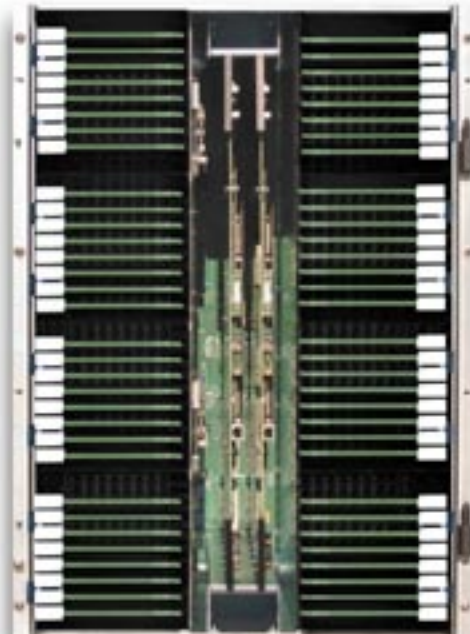
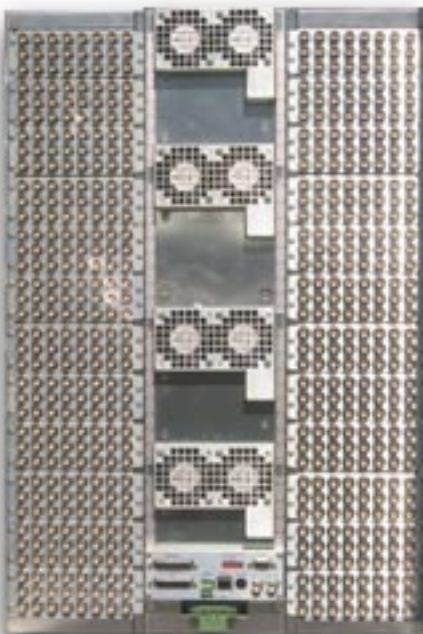
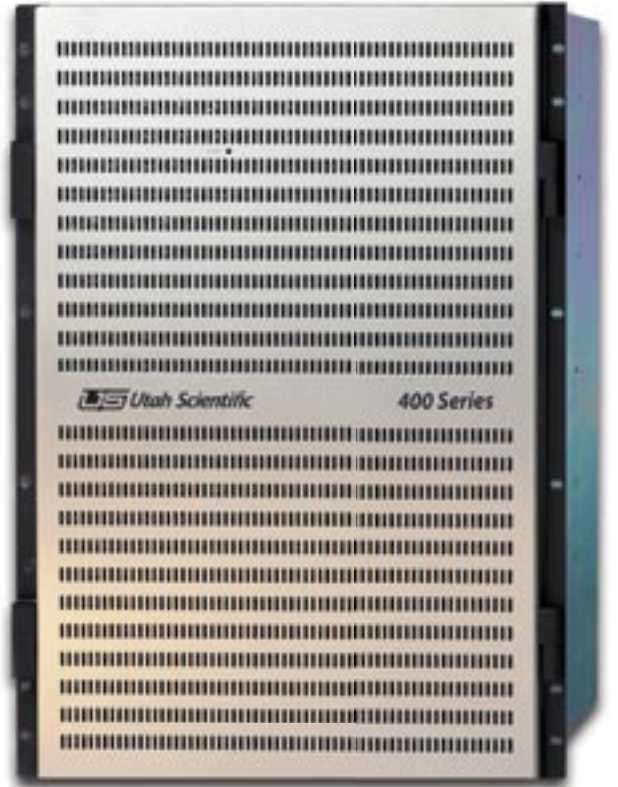

UTAH-400 SPECIFICATIONS

Digital Video Matrix

(SMPTE 259M, 292M, 424M; DVB-ASI)

Data Rates:

SD Boards:

540, 360, 270, 177, 143 Mbps

HD Boards:

above rates, plus 1.485 Gbps
and 3.0 Gbps HD Signals

(Other rates from 3Mbps to 3Gbps can be
handled by disabling the output reclocking)

Input Return Loss

to 1.5GHz: 15 dB

to 3.0GHz: 10dB

Automatic Input Equalization (8281 coax)

143,177,270 Mbit/s: 1000 ft

1.5Gbps and 3Gbps: 300 ft

Signal Level 800mV p-p $\pm 10\%$

Output Return Loss

to 1.5GHz 15 dB

to 3.0GHz 10dB

Reclocking: Yes, on outputs

Analog Video I/O Option

Input Signal Standards: NTSC (RS-250C)
PAL-I

Converter Resolution: 10 Bits

Converter Delay: 1ms

A>D Conversion: 3 line adaptive comb filter

A>D Conversion Delay: 78us

Input and Output Levels:

1V p-p nominal. (100 IRE)

Input and Output Return Loss: >40dB

Differential Gain: 1.5%

Differential Phase: 1.5 degrees

Frequency Response: +/- 0.1dB to 5.5 MHz

Gain Uniformity: +/- 0.5 dB at 500 KHz

Crosstalk: -60dB

Tilt: 0.1%

Signal to Noise Ratio: -58dB

(P-P video vs. RMS noise and hum, 5 MHz b/w)

Digital Audio Matrix

(AES3id)

Balanced Differential Inputs / Outputs

(75 Ohm Unbalanced I/O option)

Input Impedance: 110 Ohms

Input Level Minimum: 200 mV p-p

Maximum: 7 V p-p

Maximum Common Mode Level: ± 7 V (DC-20 kHz)

Output Impedance: 110 Ohms

Analog Audio I/O Option

Converter Resolution: 24 Bits

(20 or 16 selectable)

Total Harmonic Distortion: 0.1%

(30 Hz to 20 KHz, +24dBm)

Hum and Noise: -85dBm (15 KHz weighting)

Crosstalk: -85 dB (20 KHz, +24dBu)

Gain Uniformity: +/- 0.15dB

Frequency Response: +/- .25dB

(20 Hz to 20 KHz)

Input Impedance: 200K

Output Source Impedance: <50 ohms

Common mode rejection: 70 dB (50/60 Hz)

Environmental

Operating Temperature Range: 0-45° C

Relative humidity: 0-90%

(non-condensing)

Power Requirements

(All supplies are UL-listed and IEC950 approved)

Input: 100-240 VAC, 50/60 Hz

Max Consumption: (Power Supply Capacity)

RF-400/32 50W

RF-400/64 150W

RF-400/144 350W

RF-400/288 1000W

Physical

EIA 19" Rack Space requirements:

RF-400/32 2RU (3.5" / 90mm)

RF-400/64 4RU (7.0" / 180mm)

RF-400/144 9RU (15.75" / 400mm)

RF-400/288 15RU (26.25" / 675mm)

(Plus AC Rectifier Frame 1RU (1.75" / 45mm))

All units are 17"/430mm deep

Notes: Specifications are for 144x144 matrix size.

Specifications are subject to change without notice.

www.utahscientific.com

E-mail: sales@utsci.com

4750 Wiley Post Way -- Suite 150

Salt Lake City, Utah 84116

Phone: +1 (801) 575-8801

Fax: +1 (801) 537-3099

Via Filli Bandiera, 52

20050 Verano Brianza (MI)

Italy

Phone: +39 0362 330 001

Thoroyaveien 11

3209 Sandefjord

Norway

Phone: +47 33 522 700

 Utah Scientific

REV. 0109